

DCX

Digital Chiropractic X-Ray

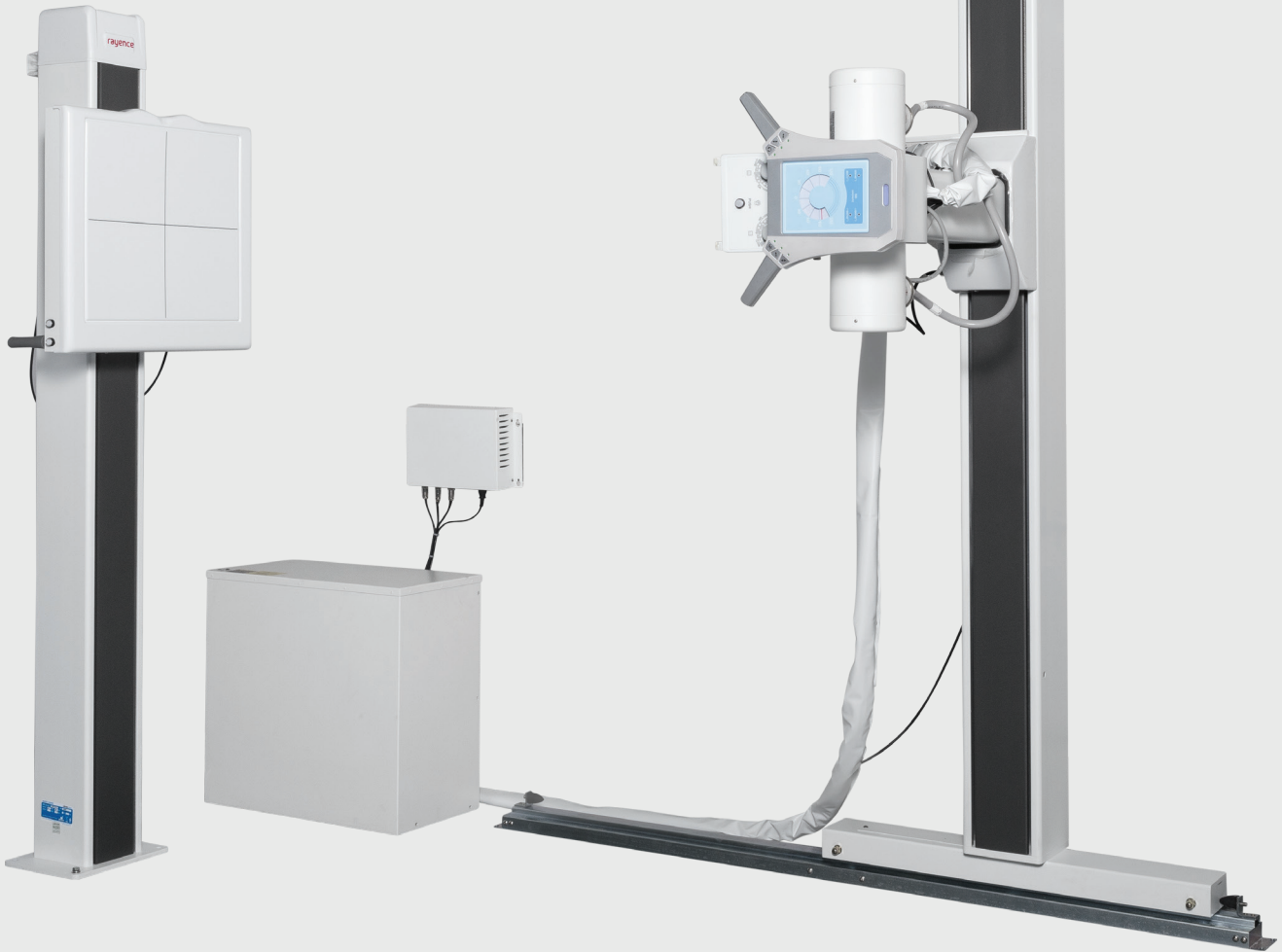

Rayence Xmaru
Chiropractic Software

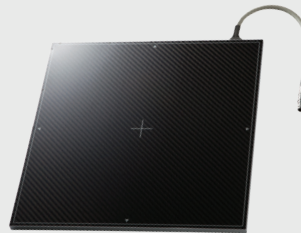

1717SCC Tethered Flat
Panel Detector



rayence

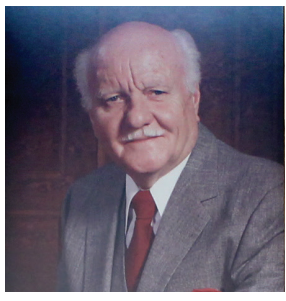

Kenneth E. Yochum, DC

Dr. Kenneth E. Yochum was a native of South St. Louis, MO where he practiced chiropractic for 45 years. He was a certified instructor in the NIMMO Receptor Tonus technique and taught with the inventor Dr. Raymond Nimmo. He was a 1936 graduate of the Missouri Chiropractic College and became an adopted alumnus of the Logan College of Chiropractic when his school closed.



**Terry R. Yochum, DC,
DACBR, Fellow, ACCR,
FICC**

Dr. Terry R. Yochum is a second-generation chiropractor and a cum laude graduate of the National College of Chiropractic, where he subsequently completed his radiology specialty. Dr. Terry R. Yochum is currently Director of the Rocky Mountain Chiropractic Radiological Center in Denver, Colorado, and an Adjunct Professor of Radiology at the Southern California University of Health Sciences (formerly LACC) and the University of Colorado School of Medicine.



**Alicia M. Yochum RN, DC,
DACBR, RMSK**

Dr. Alicia M. Yochum received her Bachelor of Science in Nursing from Point Loma Nazarene University and then worked in the ICU for one year before matriculating to Logan College of Chiropractic. She completed her diagnostic imaging residency at Logan in 2015, and received her DACBR in October of 2015, becoming the first second-generation DACBR in the history of chiropractic. She has completed a fellowship in musculoskeletal diagnostic ultrasound at Logan University.

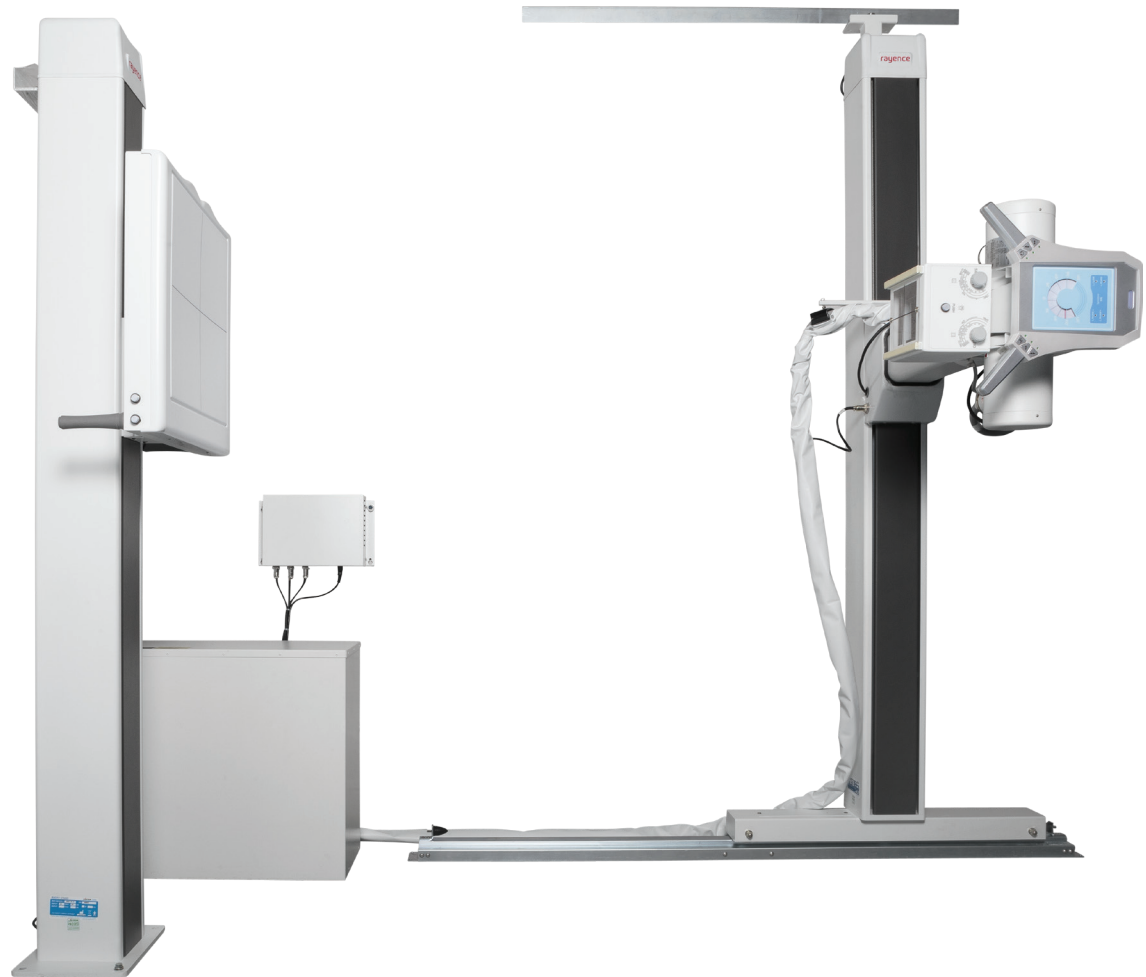

Raising the Bar for Chiropractic Care

The Rayence DCX Integrated Digital Chiropractic room package seamlessly combines flexibility, efficiency, and convenience at an affordable price. The DCX uses the latest in DR technology which will instantly improve workflow by eliminating the need for conventional X-ray film, storage, and processor. Powered by the Rayence 1717SCC Cesium fixed DR detector, the DCX gives staff and clinicians immediate access to high-resolution digital images with extensive post-processing capability and the ability to share those images within the office in seconds. The DCX features a floor-wall tube stand and a compact wall stand that delivers extensive vertical travel allowing for a full range of upright positions. The tube stand includes electromagnetic brakes and a fixed positioning tube arm for easy and accurate alignment to the wall stand for SID's of 40 to 72". The DCX x-ray generator is integrated into the DR workstation to simplify technique settings before and during an exam so that all changes can be made from the DR workstation console. The DR systems post processing software includes over 50 specific chiropractic measurement tools along with Rayence's latest ClearOn image processing software. Finally, the workstation permits sharing of the stored images by use of our advanced image viewer software with as many as 10 in-office computers to facilitate the review of images with patients.

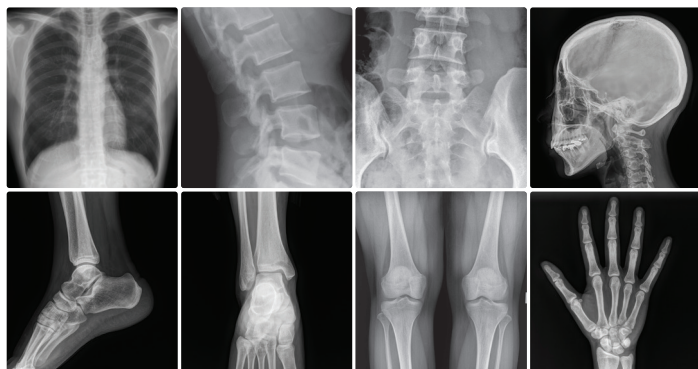
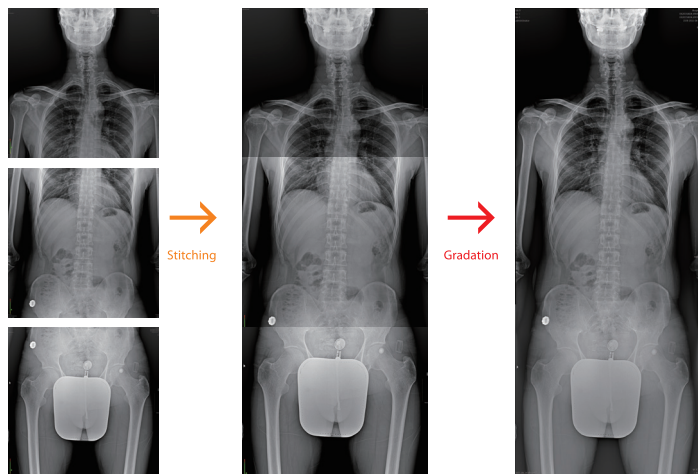

Image Processing

- Perfect Image Acquisition (No Adjustment Required)
- Integration Software for Automatic Image Optimization
- Professional Image Processing for Diagnostic Use
- Easy Observation for Bones and Microstructures
- Noise Suppression



Harmonic Stitching (optional)

Image stitching is achieved by selecting one of three methods: Full Auto, Semi-Auto or Manual. To eliminate the exposure borders of each image due to varying densities, Rayence's advanced gradation process is automatically applied.

Together with Rayence's optional automatic stitching software, up to three views can be automatically stitched at a touch of a button, making stitching examinations easier than ever to attain.

Advanced Workflow & Intutive GUI

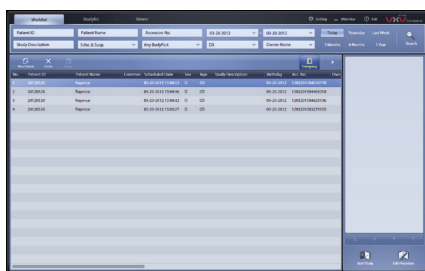

1. Worklist



2. Edit Procedure (Graphic Mode)



3. Generator Control

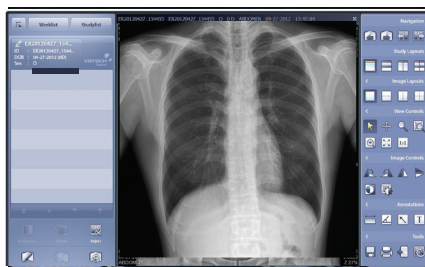

4. Capture



5. Studylist

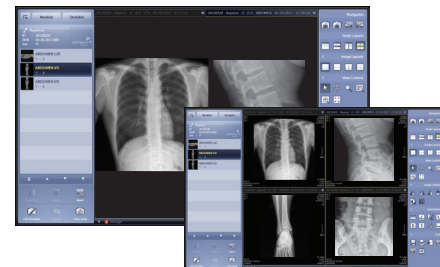

6. Viewer (Image Layout & Study Layout)

Complete Acquisition Software

- User-friendly data searching
- Fast Image Acquisition
- Image Viewing
- Reprocessing
- Optimizing and Archiving

Intutive GUI

- Intuitive and Direct Graphic User Interface with X-ray Detector and Generator
- Optimized Exposure Conditions and Image Review

DCX

Digital Chiropractic X-Ray

Descriptions		Technical Specifications
Tube Stand	Min. Tube Center Height	14.0in (36cm)
	Max. Tube Center Height	73in (185.4cm)
	Floor/Wall Rail Length	76in (193cm)
	Floor/Ceiling Rail Length	72.04in (183cm)
	Maximum Ceiling Height	106in (269cm)
	Minimum Ceiling Height	94.5in (240cm)
	Tube Rotation	240° Tube Rotation
Power Requirement		24VDC
Wall Stand	Wall Stand Height	78.74in (200cm)
	Detector Bucky Height	23.38in (59.4cm)
	Vertical Travel Range	59in (149.8cm)
	Wall Stand Width (With Detector)	23.25in (59cm)
	Wall Stand Depth (With Detector)	13in (33cm)
	Max. Bucky Center Height	73.22in (186cm)
	Min. Bucky Center Height	14in (35.6cm)
	Fixed Detector	Shoots Right/Shoots Left
Power Requirements		24VDC
Tube	Toshiba E7242	1.0/2.0 Focus, 200KHU
Grid		
Collimator	Collimator	M-38 LED
Detector	1717SCC	17in x 17in (43cm X 43cm)
Generator	Generator	40kW, 1 Phase
		10 - 500ma
		220/240VAC

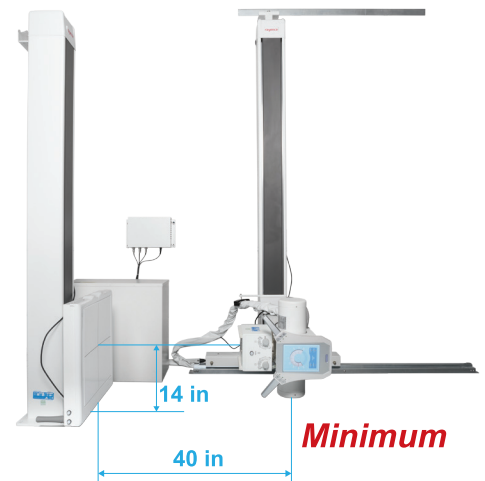
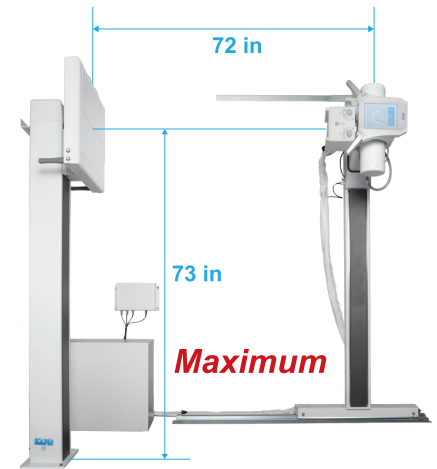
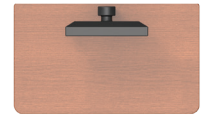
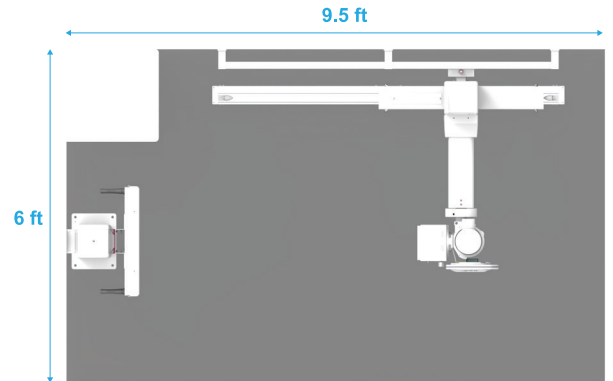

1717SCC

Tethered Flat Panel Detector

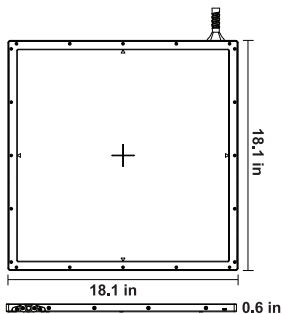

The 1717SCC is Rayence's top cesium digital detector for today's chiropractic practices. The Rayence 1717SCC uses the latest image processing, ClearON, making chiropractors' best shot, their first shot. The chiropractic package includes a mini-archive with advanced viewers and over 50 chiropractic specific measuring tools.

Descriptions	Technical Specifications	
Scintillator Type	CsI:TI	-
Dimension	18.1 x 18.1 x 0.6	in
Pixel Pitch	140	µm
Limiting Resolution	Min. 2.5 / Max. 3.57	lp / mm

Dealer Information:

rayence

